



Experience Innovation

Model: 2" Utility Trash Pump

Name: 2T

Thompson Utility Trash Pumps provide high performance with the mobility of lightweight cast aluminum housing. With a replaceable volute, housing, impeller and wear plate, worn parts can be easily replaced in the field, saving time and money. For durability, portability and flexibility, the 2T performs over the long haul with low maintenance for continued service.



Photo shown may not be exact model.
Consult factory for options.

Pump End Materials	
Pump Casing	Rugged, heavy-duty cast aluminum with replaceable volute. Priming and drain covers fitted with wrench nuts that can be removed without special tools.
Impeller	Dynamically balanced, two vane, non-clogging, semi-open, class 30 cast iron with rear-equalizing vanes to reduce axial loading and prolong seal and bearing life. Diameter 5.1".
Wear Plate	Replaceable, class 30 cast iron with abrasion resistant rubber facing for extended service life.
Mechanical Seal	Grease lubricated with Silicon Carbide rotating and stationary seal faces. Single inside mounted, non-pusher type with self-adjusting elastomeric bellows. All other components are 304 stainless steel and Viton.
Suction Check Valve	Built-in weighted, full-flow valve to eliminate re-priming with each cycle. Constructed of cast-iron and two-ply nitrile rubber with nylon reinforcement.

Technical Specifications			
Suction Size	2 in (5.08 cm)	Approximate Dry Weight	350 lbs (158.76 kg)
Discharge Size	2 in (5.08 cm)	Fuel Capacity	3.88 Qts. (3.67 L)
Maximum Solids Handling	1.06 in (2.69 cm)	Maximum Operating Speed	3,600 rpm
Maximum Operating Temperature	200° F (93.33° C)	Maximum Operating Pressure	41 psi (282.51 kPa)

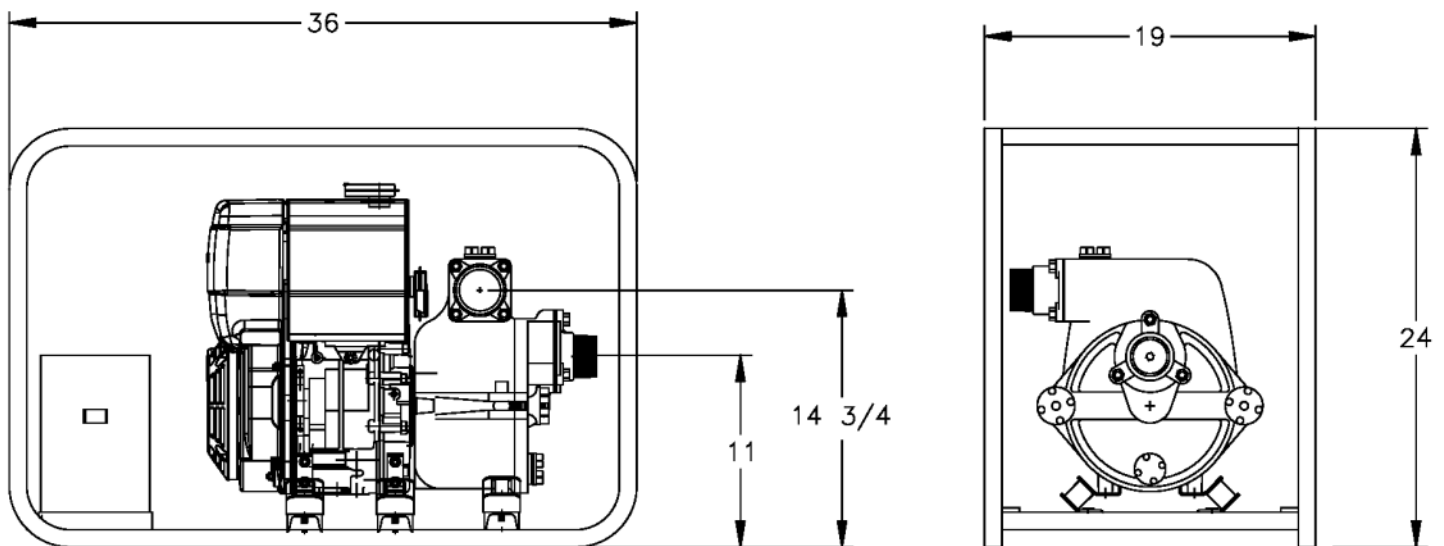
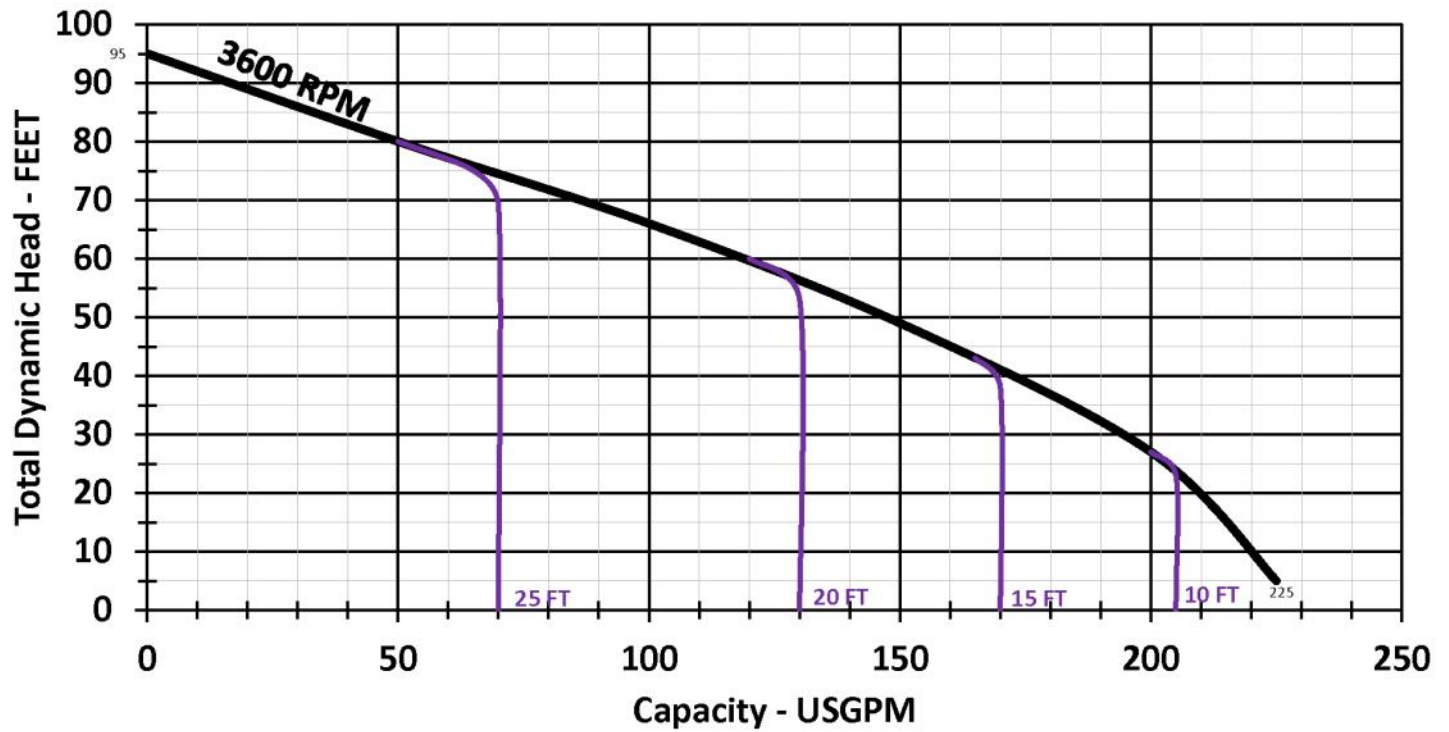

Honda GX160 (Gas) — 3.9 hp @ 3,600 rpm

Typical Operating Speed	3,600 rpm
Maximum Head	95 ft (28.96 m)
Maximum Flow Capacity	225 gpm (51.1 m ³ /hr)

Specifications and illustrations are subject to revision without notice and without incurring any obligation for previous or subsequent equipment sold. Thompson Pump (ISO 9001:2015) makes no representation regarding the completeness or accuracy of this information and is not liable for any direct or indirect damages arising from or relating to this information or its use. Capacity & Head are shown for comparative purposes. Consult Thompson factory for exact capabilities.